

4L40E 4 SPEED, 5L40E 5 SPEED (M82), 5L50E (M22) - ELECTRONIC - RWD

REVERSE AND DIRECT CLUTCH HOUSING ASSEMBLY

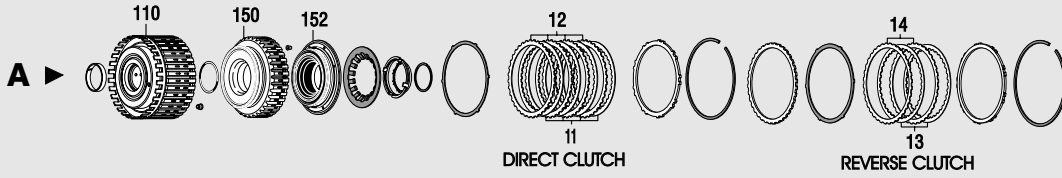

FORWARD AND COAST CLUTCH HOUSING ASSEMBLY

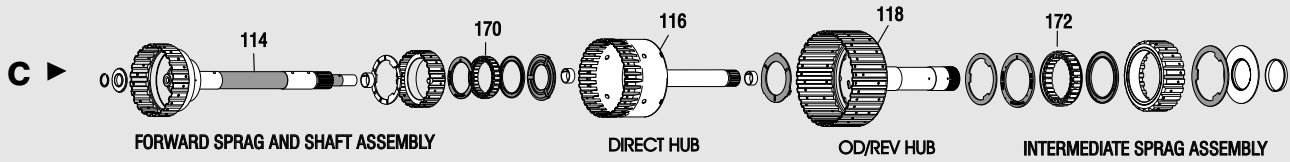
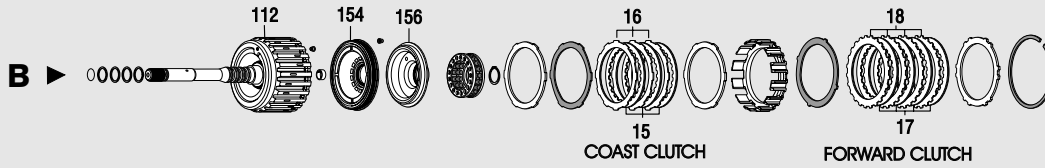

INTERMEDIATE AND OVERDRIVE CLUTCH HOUSING ASSEMBLY

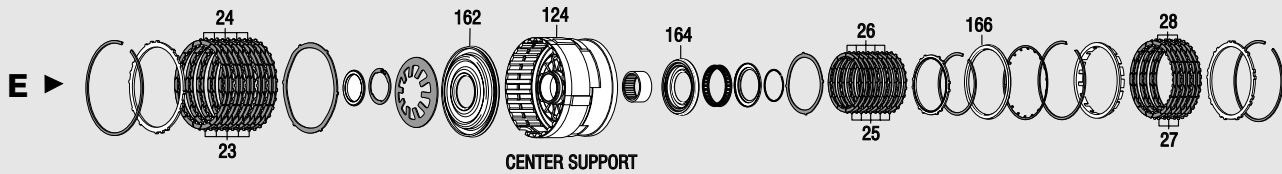
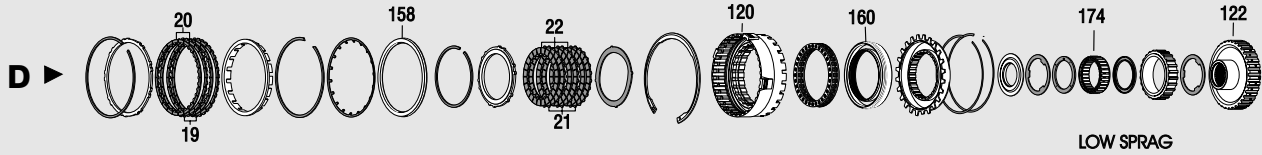

2ND SPRAG PLANETARY SYSTEM

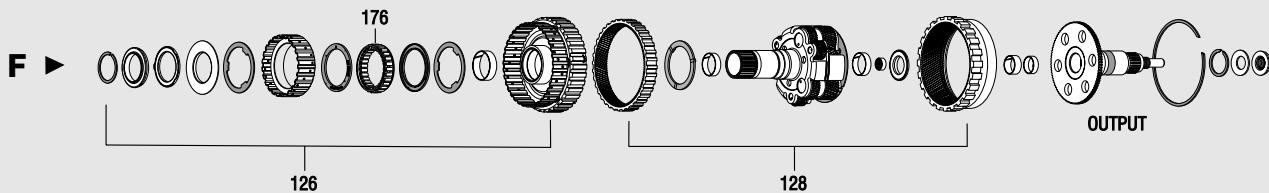

4L40E 4 SPEED, 5L40E 5 SPEED (M82), 5L50E (M22) - ELECTRONIC - RWD

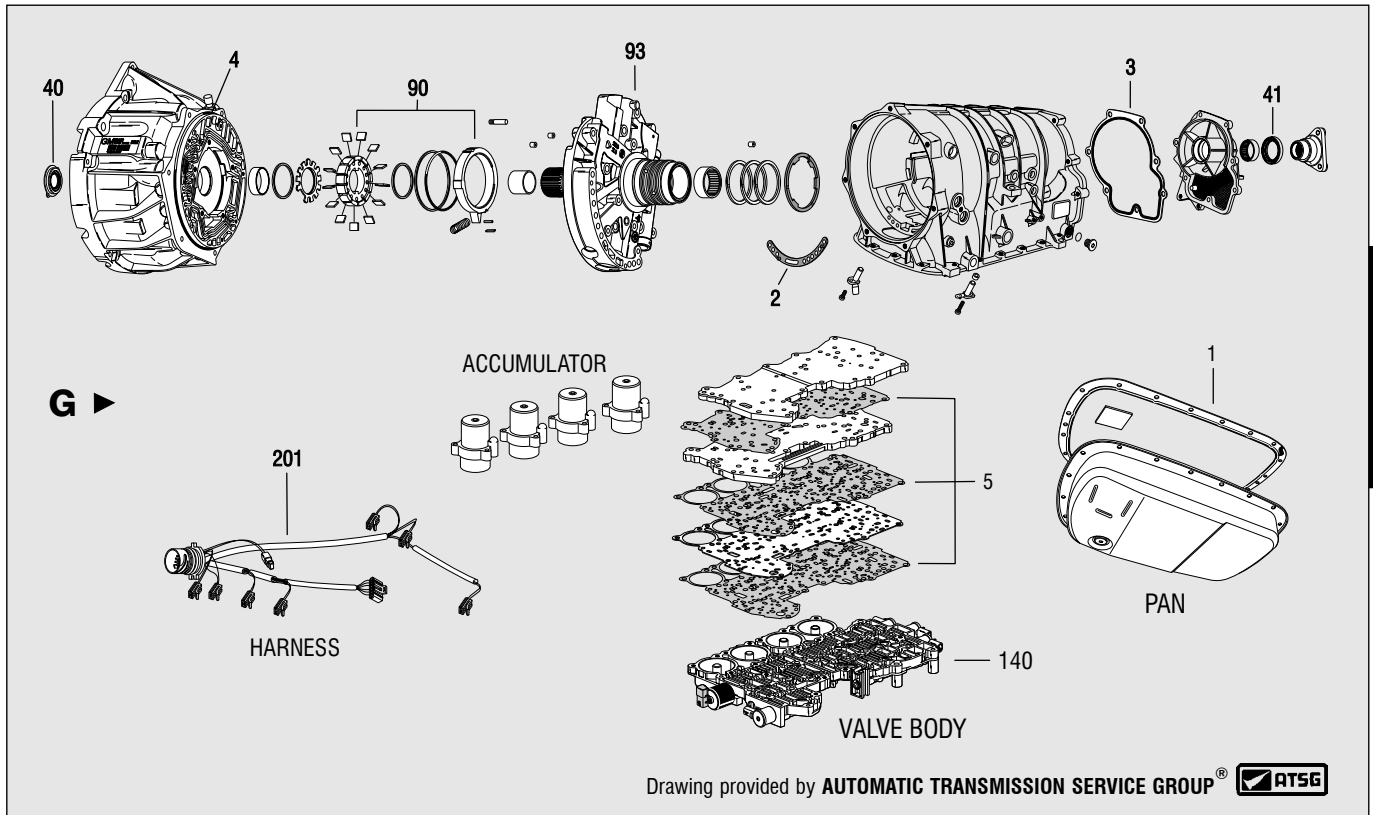

4L/5L40E/5L50E

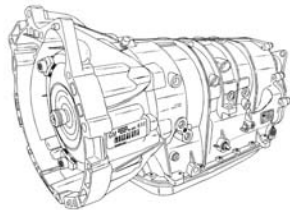

BMW (4L/5L40E)	99-Up
Cadillac CTS (5L40E)	03-Up
XLR (5L50E)	04-Up

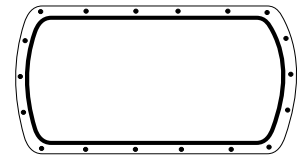

20 Bolt Pan

REBUILDER KITS

			DELUXE	MASTER	LESS STEELS	OVERHAUL	GASKET &
To order Kits with all Borg Warner frictions, use a "KB" prefix instead of the traditional "K" prefix.							
Rebuilder Kit - 4 Spd - 4L40E	1	99-Up		K4100N	K4100N-LS	K41900M	
Rebuilder Kit - 5 Spd - 5L40E/5L50E	1	99-Up		K4100M	K4100M-LS	K41900M	

ILL.	DESCRIPTION	QTY.	YEAR	PART NO.	REFERENCE NO.
MISCELLANEOUS GASKETS & SEALS/PAN GASKETS					
1G	Gasket - Oil Pan (Molded)	1	99-Up	13600MR	96041861
2G	Gasket - Front Pump To Case	1	99-Up	13601M	N.L.
3G	Gasket - Extension Housing	1	99-Up	13927M	N.L.
4G	Seal - Front Pump	1	99-Up	13602M	N.L.
5G	Gasket Package - Valve Body	1	99-Up	K13616M	N.L.

4L40E 4 SPEED, 5L40E 5 SPEED (M82), 5L50E (M22) - ELECTRONIC - RWD

ILL.	DESCRIPTION	QTY.	YEAR	PART NO.	REFERENCE NO.	
CLUTCH PLATES						
Order Frictions with prefix: "B" for Borg Warner brand, "R" for Raybestos brand, and "J" for Dynax.						
11A	Friction - 1 Sided Facing: - Direct CL - I.D. Tooth -	4-5	99-Up	41104M	N.L.	
12A	- Direct CL - O.D. Tooth -	4-5	99-Up	41105M	N.L.	
13A	- Reverse CL- I.D. Tooth -	2	99-Up	41100M	N.L.	
14A	- Reverse CL- O.D. Tooth -	2	99-Up	41101M	N.L.	
17B	- Forward CL - I.D. Tooth -	4	99-Up	41110M	N.L.	
18B	- Forward CL - O.D. Tooth -	4	99-Up	41111M	N.L.	
15B	- Coast CL - I.D. Tooth -	3	99-Up	41108M	N.L.	
16B	- Coast CL - O.D. Tooth -	3	99-Up	41109M	N.L.	
19D	- Overdrive CL - I.D. Tooth -	2-3	99-Up	41100M	N.L.	
20D	- Overdrive CL - O.D. Tooth -	2-3	99-Up	41101M	N.L.	
21D	- Intermediate CL - I.D. Tooth -	3-4	99-Up	41106M	N.L.	
22D	- Intermediate CL - O.D. Tooth -	3-4	99-Up	41107M	N.L.	
23E	- Low/Reverse CL - I.D. Tooth -	5-6	99-Up	41104M	N.L.	
24E	- Low/Reverse CL - O.D. Tooth -	5-6	99-Up	41112M	N.L.	
25E	- 2nd CL - I.D. Tooth - (5 Speed Only)	5-6	99-Up	41102M	N.L.	
26E	- 2nd CL - O.D. Tooth - (5 Speed Only)	5-6	99-Up	41103M	N.L.	
27E	- 2nd Coast - I.D. Tooth - (5 Speed Only)	3	99-Up	41104M	N.L.	
28E	- 2nd Coast - O.D. Tooth - (5 Speed Only)	3	99-Up	41105M	N.L.	
FILTERS/FILTER KITS						
Order Filter Kits with 'FK' prefix for Cork & Neoprene, 'FFK' prefix for Fibre.						
N.I.	Filter Kit - Oil - w/o neck spacer, w/o 1/2" inlet (Shallow Pan)	1	99-Up	FK41800M	N.L.	
N.I.	Filter Kit - Oil - w/ neck spacer, w/o 1/2" inlet (Deep Pan)	1	99-Up	FK41800N	N.L.	
N.I.	Filter Kit - Oil - w/ neck spacer, w/ 1/2" inlet (Deep Pan)	1	99-Up	FK41800P	N.L.	
N.I.	Filter - Oil - w/o neck spacer, w/o 1/2" inlet (Shallow Pan)	1	99-Up	41800M	N.L.	
N.I.	Filter - Oil - w/ neck spacer, w/o 1/2" inlet (Deep Pan)	1	99-Up	41800N	N.L.	
N.I.	Filter - Oil - w/ neck spacer, w/ 1/2" inlet (Deep Pan)	1	99-Up	41800P	N.L.	
METAL CLAD SEALS						
40G	Front Pump	1	99-Up	41151F	96020366	
41G	Extension Housing	1	99-Up	41201F	96020744	
HARD PARTS						
<p>Hard Parts may only require the base number for OEM/Aftermarket New. A "N" suffix may also be required. Use a "D" prefix for Delco, or a "-R" suffix for remanufactured. Exceptions are listed individually. NOTE: A separate column is provided to indicate a primary or specific brand/type.</p>						
ILL.	DESCRIPTION	BRAND	QTY.	YEAR	PART NO.	REFERENCE NO.
90G	Pump - Rotor/Slide Kit		1	99-Up	K41201M	N.L.
93G	Pump Cover		1	99-Up	41424M	N.L.
110A	Direct/Reverse Housing	R	1	99-Up	41962M	N.L.
112B	Forward/Coast Housing	R	1	99-Up	41963M	N.L.
120D	Intermediate/Overdrive Housing	R	1	99-Up	41964M	N.L.
124E	Low/Reverse/2nd Clutch Housing - (5 Speed Only)	R	1	99-Up	41965M	N.L.
124E	Low/Reverse Housing - (4 Speed Only)	R	1	99-Up	41965BM	N.L.
114C	Forward Sprag/Shaft Assembly	R	1	99-Up	41970M	N.L.
116C	Direct Clutch Hub	R	1	99-Up	41972M	N.L.
118C	Overdrive/Reverse Hub - w/Intermediate Sprag	R	1	99-Up	41974M	N.L.
122D	Low Sprag Assembly	R	1	99-Up	41976M	N.L.
126F	2nd Sprag Assembly - (5 Speed Only)	R	1	99-Up	41978M	N.L.

4L40E 4 SPEED, 5L40E 5 SPEED (M82), 5L50E (M22) - ELECTRONIC - RWD

ILL.	DESCRIPTION	BRAND	QTY.	YEAR	PART NO.	REFERENCE NO.
HARD PARTS (Cont.)						
128F	Planetary Package - w/Ring Gear - (5 Speed Only)	R	1	99-Up	K41950M	N.L.
128F	Planetary Package - w/Ring Gear - (4 Speed Only)	R	1	99-Up	K41950BM	N.L.
140G	Valve Body - (5 Speed Only)	R	1	99-Up	41990	N.L.
140G	Valve Body - (4 Speed Only)	R	1	99-Up	41990B	N.L.
	Piston: Bonded					
150A	- Reverse		1	99-Up	41531	N.L.
152A	- Direct		1	99-Up	41532	N.L.
154B	- Forward		1	99-Up	41533	N.L.
156B	- Coast		1	99-Up	41534	N.L.
158D	- Overdrive		1	99-Up	41535	N.L.
160D	- Intermediate		1	99-Up	41536	N.L.
162E	- Low/Reverse		1	99-Up	41537	N.L.
164E	- 2nd - (5 Speed Only)		1	99-Up	41538	N.L.
166E	- 2nd Coast - (5 Speed Only)		1	99-Up	41539	N.L.
	Sprag:					
170C	- Forward		1	99-Up	41960M	N.L.
174D	- Low		1	99-Up	41960P	N.L.
176F	- 2nd - (5 Speed Only)		1	99-Up	41960R	N.L.
172C	- Intermediate		1	99-Up	41960S	N.L.
ELECTRICAL PRODUCTS						
	Solenoid:					
N.I.	- EPC (Holley)		1	99-03	5D-186	96041868
	- EPC (Bosch)		1	04-Up	5D-186B	24225825
	- TCC		1	99-Up	5A-187	24212690
	- Shift					
N.I.	- 1-2		1	99-Up	5A-555	N.L.
N.I.	- 2-3		1	99-Up	5A-555	N.L.
N.I.	- 4-5		1	99-Up	5A-555	N.L.
201G	Harness - Internal		1	99-Up	35A-555	N.L.
MISC						
N.I.	Technical Manual - 4L40E/5L40E		1	-	41Y05	N.L.
NOTES						

4L/5L40E/5L50E